

Driving Base

Check that your RCX has working batteries before starting.

1

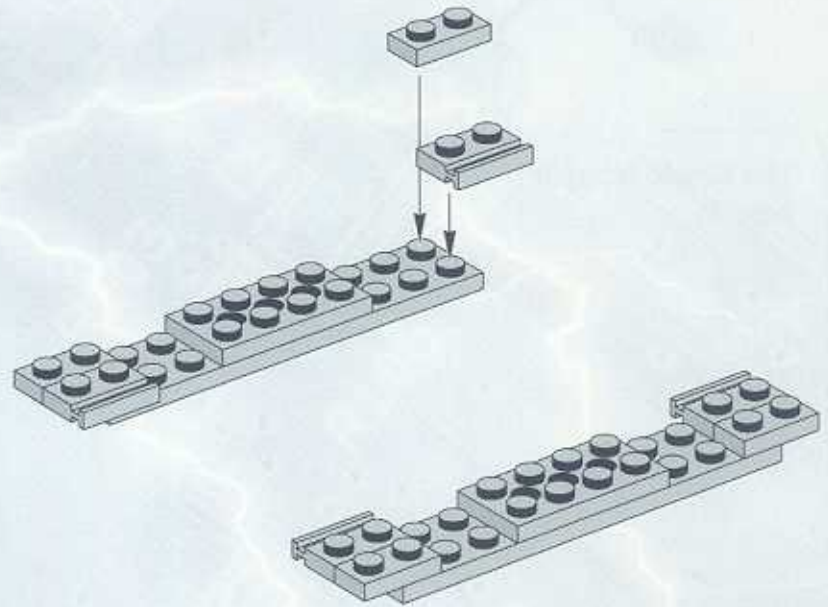
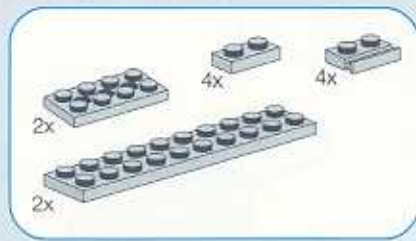

2

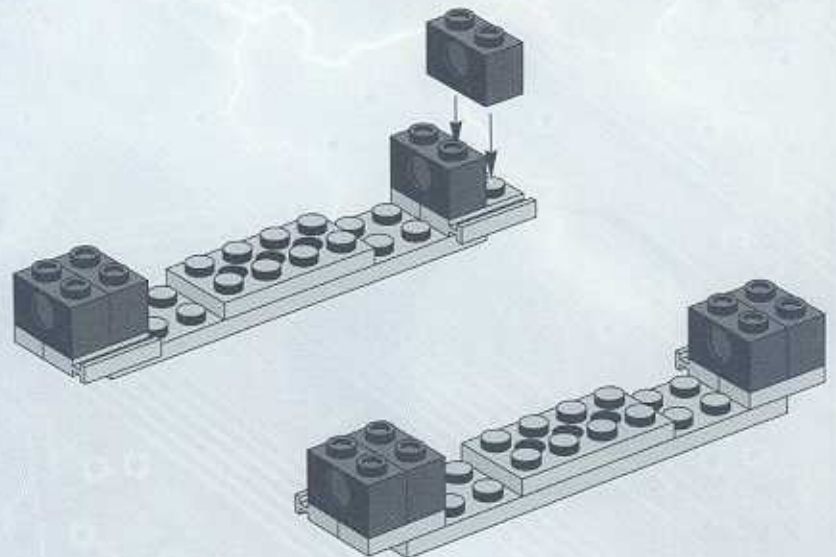



3

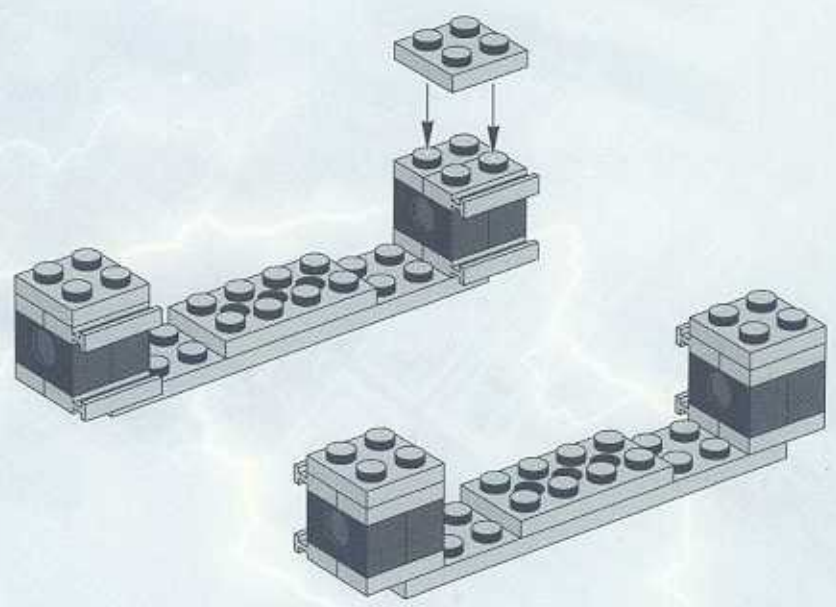

4

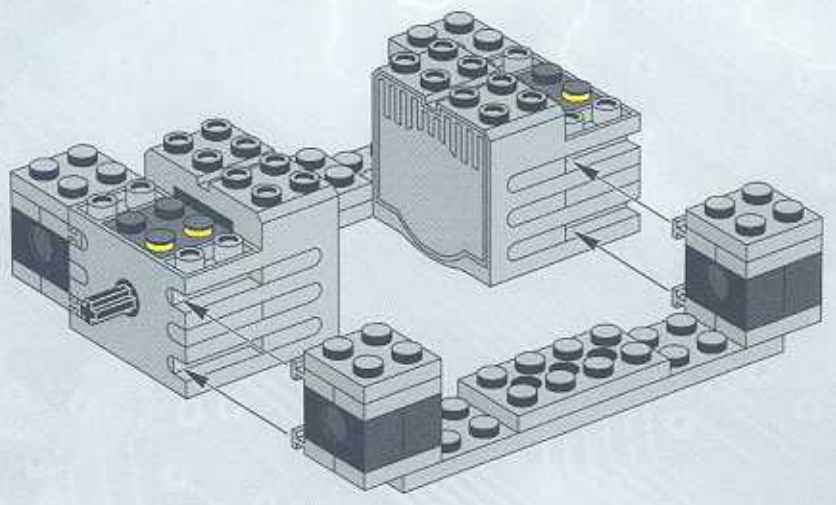



5

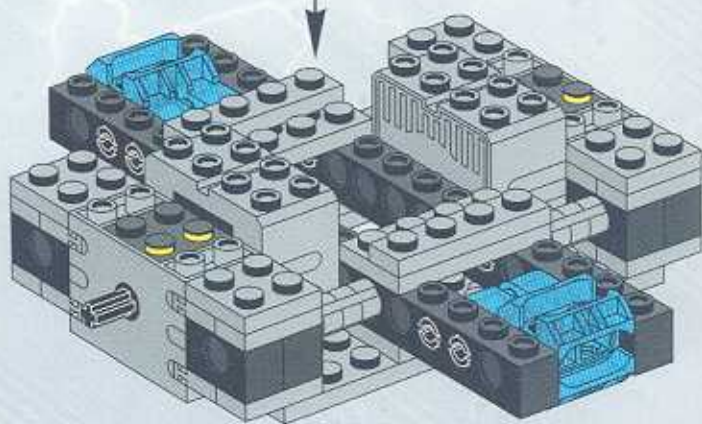
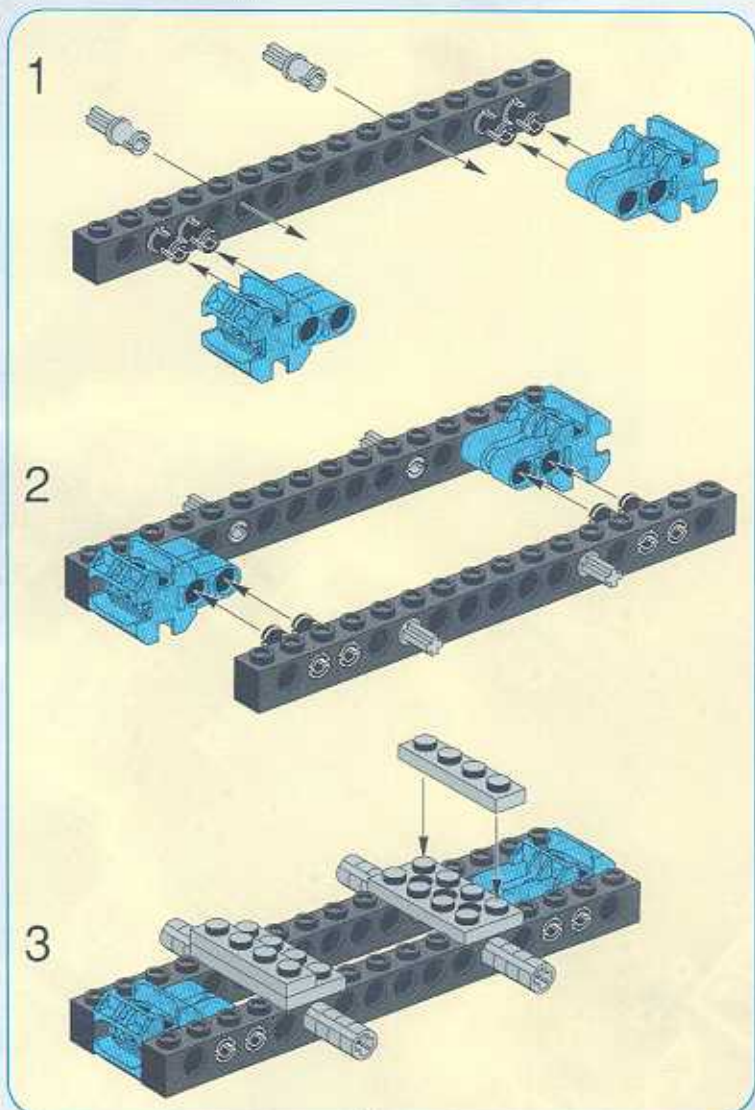
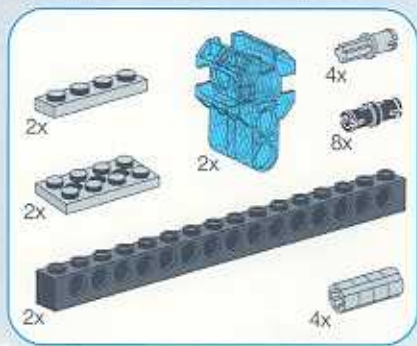

6

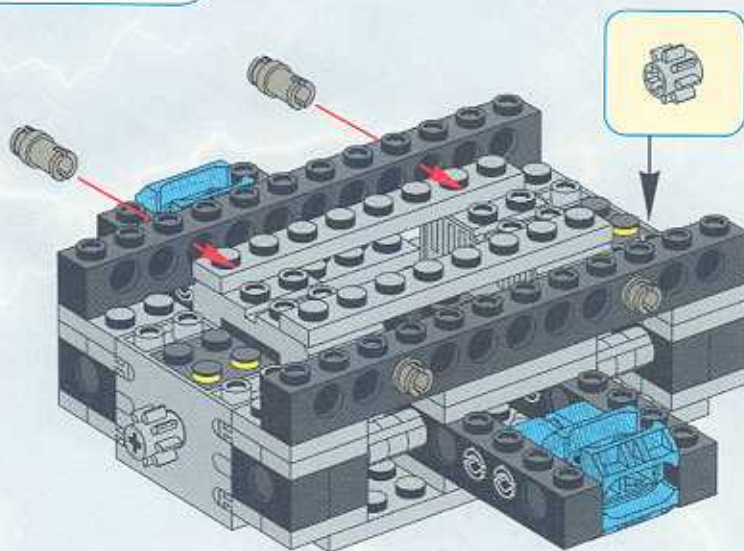
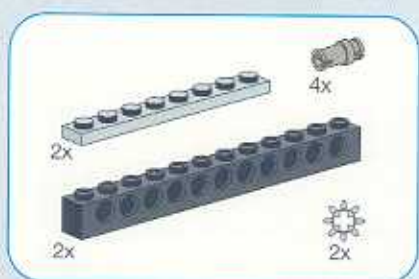

7

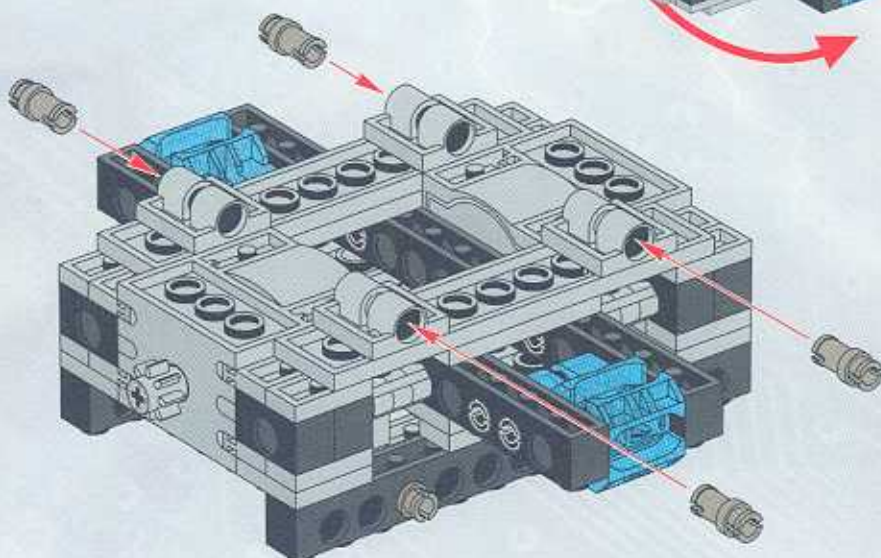
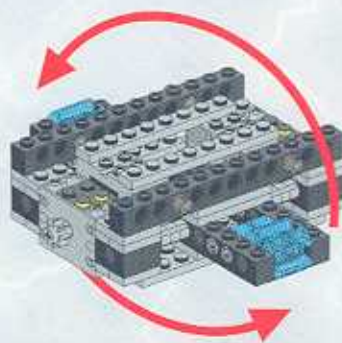



8

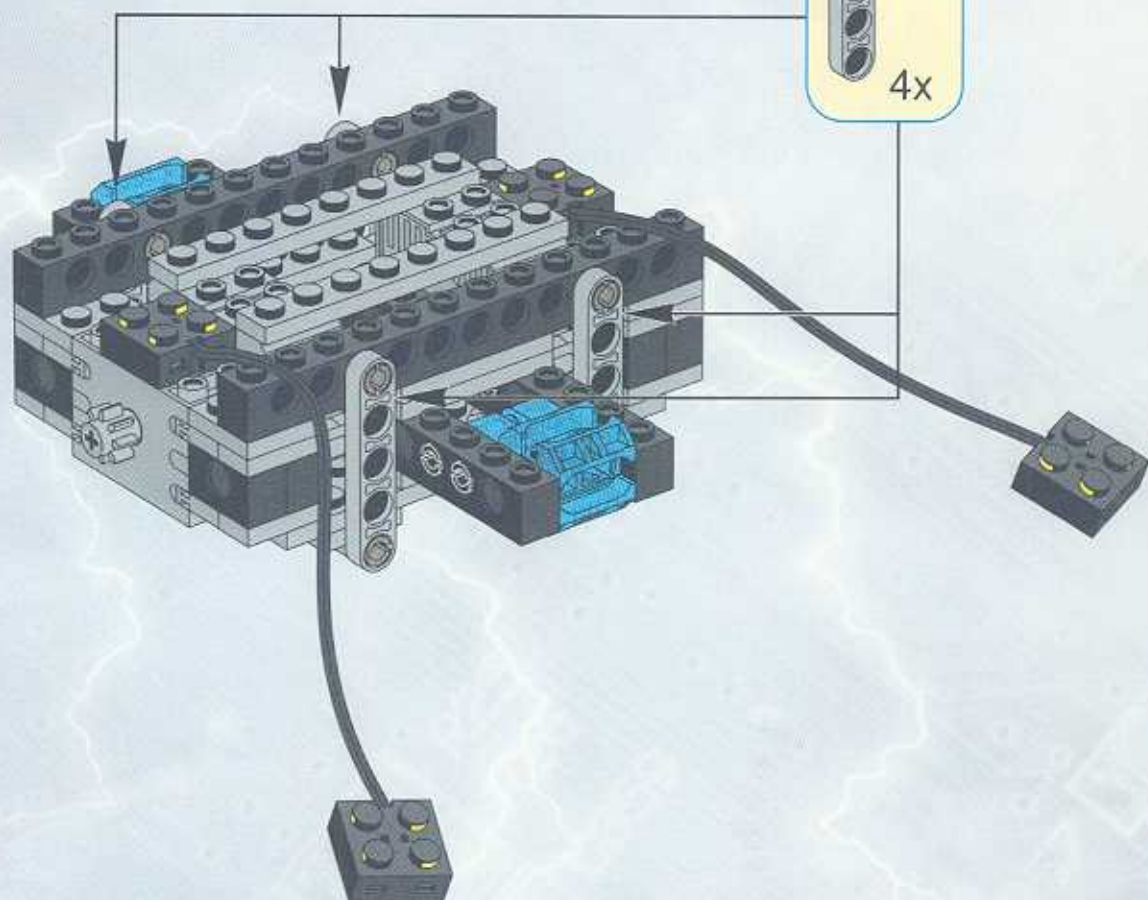

9

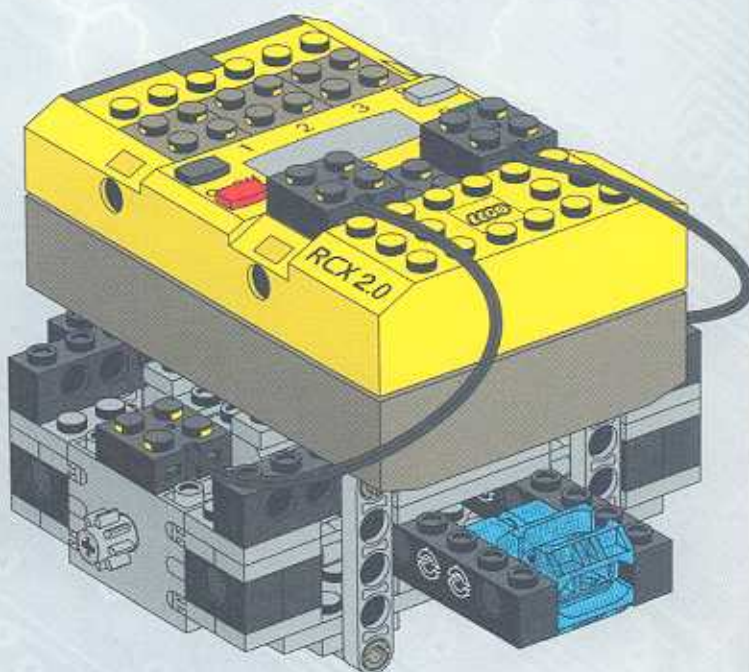
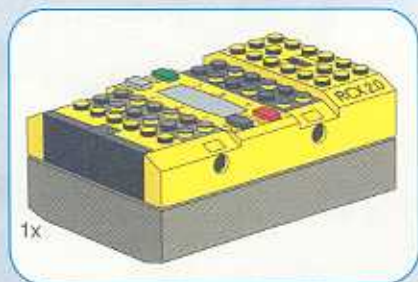

This is the Driving Base for the Roverbot. Be sure to attach the wires as shown.

Wheel Sets

1

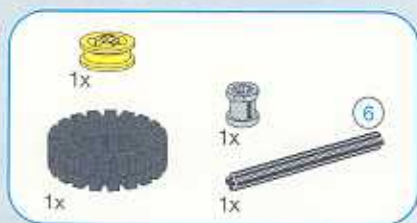

2

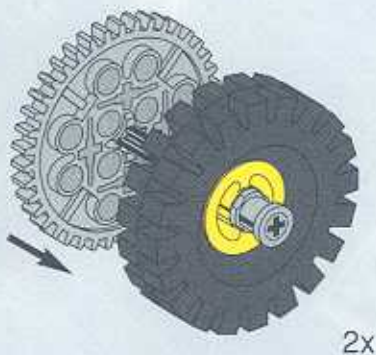

1

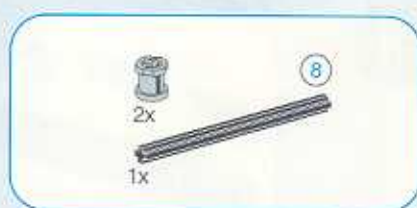

2

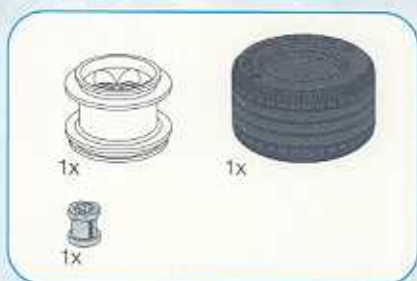

3

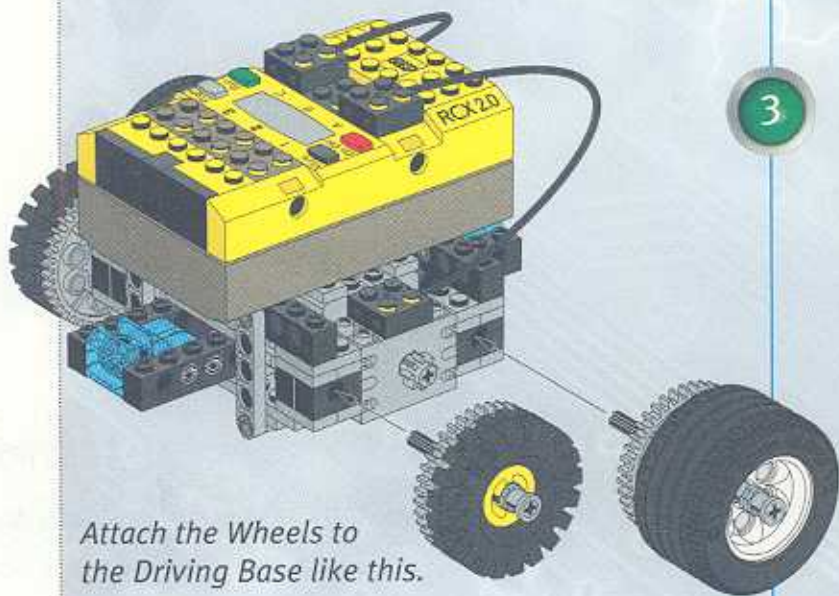
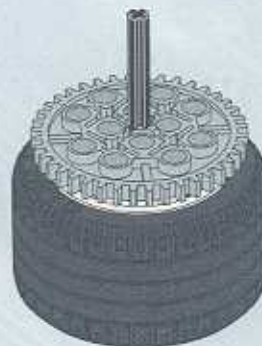

Attach the Wheels to the Driving Base like this.

If you have not yet built the Driving Base, go to page 12.